



*Vaš dom - vaše kraljestvo*

# *Avalon*

*Your home - your kingdom*

*tipska karta / model list*

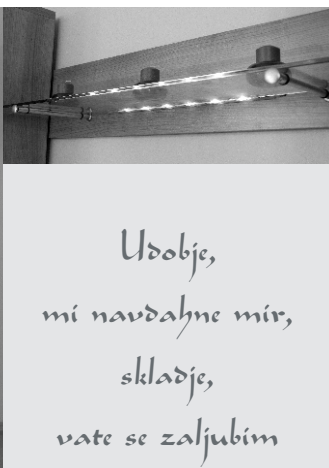

*Udobje,  
mi navdahne mir,  
skladje,  
vate se zaljubim*



## Tehnični podatki / Technical data

### MATERIAL:

Program **Avalon** je izdelan iz oplemenitene iverne plošče, izbočene ličnice in okvirji pri steklenih vratih pa iz vlaknene plošče. Vsi vidni robovi so obdelani z ABS folijo. Ogrodja so postavljena na PVC nivelirne nogice.

### BARVA:

Ogrodja elementov so v barvi **češnje**. Vrata in ličnice pa so poleg barve češnje dobavljive še v **bordo rdeči** in **bež** barvi. Bordo in bež fronte so lakirane, kar daje **Avalonu** še dodatno eleganco. Ročaji in podnožja pisalnih miz so kovinski v mat krom barvi.

### KOMPANIBILNOST:

Program **Avalon** je modularni sistem pohištva, kar pomeni sestavljanje sestavov iz določenega števila ponujenih ogrodij omar, omaric, raznih stojal, sten s policami, klubskih mizic, pisalnih miz, predalnikov, itd. Veliko sestavov je predstavljenih v nadaljevanju.

S programom **Avalon** si lahko opremito **dnevno sobo, mladinsko sobo, predsobo, pisarno, jedilnico in še kaj**. Na voljo imate pet višin in dve širini ogrodij, pri dveh najnižjih pa je možno tudi obešanje na zid. Na ogrodja lahko poljubno kombinirate vrata in ličnice iz ponudbe. Veliko kombinacij je predstavljenih v nadaljevanju. **Pri montaži pa lahko še postavitev predalov in vrat po svojem okusu spreminjate.**

### PAKIRANJE:

Elementi so v demontažni izvedbi pakirani v embalaži iz lepenke.

### OPOZORILO

Pri vseh elementih, ki imajo več oznak, le te označujejo različno barvo front, kar je razvidno iz cenika..

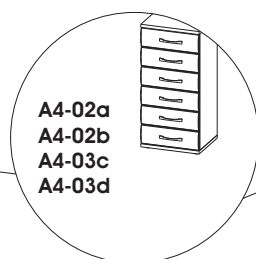

### WARNING

Availability of colours for different fronts is defined with codes beside each elements and is seen in the price list.

### MATERIAL:

Programme **Avalon** is produced from chipboard decorated with melamine foil, except convex fronts and slats for glass doors are made from MDF (medium density fiberboard). All visual edges are treated with ABS foil. Frameworks are standing on PVC legs with height adjustment.

### COLOUR:

Frameworks of the elements are in the cherry colour. Doors and drawer fronts are beside cherry colour also available in **biege** and **bordo red**. Bordo and biege fronts are lacquered, which makes **Avalon** even more elegant. Handles and legs for office tables are metal in matt chrome colour.

### COMPONENT SYSTEM:

Programme **Avalon** is modular sistem of furniture. That means, that you can build a composition from wide pallet of frameworks, small cabinets, racks, walls with shelves, coffee tables, office tables, drawers, etc. A lot of compositions are presented further in this document.

With **Avalon** you can build yourself a **living room, youth room, hall, office, dining room** and wherever you find it fitting.

You can choose between five heights and two widths of frameworks. The lowest two can also be hanged on the wall. On frameworks, you can combine different variations of doors and drawers. Many of combinations are presented further in this document.

**When assembling, you can change position of doors and drawers, according to your desire.**

### PACKING:

Elements are not assembled and packed in cardboard packages.

### OPOZORILO

Pri elementih s steklenimi vrati, so v elementih vključene steklene police, pri polnih vratih pa lesene police.

### WARNING

Elements with glass doors include glass shelves and elements with wooden doors include wooden shelves.

# Ogradja in posamezni elementi / Frameworks and single elements

Omarica globoka 1D s podnožjem  
Deep 1D cabinet with the base

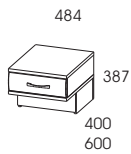

**A1-01a**  
**A1-01b**  
**A1-01c**  
**A1-01d**

Omarica globoka 1D s predalom v podnožju  
Deep 1D cabinet with drawer in the base

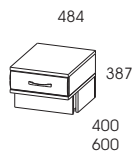

**A1-02a**  
**A1-02b**  
**A1-02c**  
**A1-02d**

Omarica globoka 2D s podnožjem  
Deep 2D cabinet with base

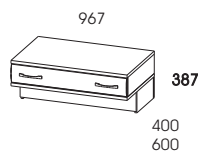

**A1-03a**  
**A1-03b**  
**A1-03c**  
**A1-03d**

Omarica globoka 2D s predalom v podnožju  
Deep 2D cabinet with drawer in the base

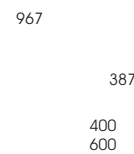

**A1-04a**  
**A1-04b**  
**A1-04c**  
**A1-04d**

Omarica mala 1D / MOŽNO OBESITI NA STENO  
Cabinet 1D height 01 / POSSIBLE TO HANG ON THE WALL

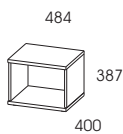

**A2-01**

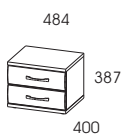

**A2-02a**  
**A2-02b**  
**A2-02c**  
**A2-02d**

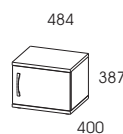

**A2-03a**  
**A2-03b**  
**A2-03c**

Omarica mala 2D / MOŽNO OBESITI NA STENO  
Cabinet 2D height 01 / POSSIBLE TO HANG ON THE WALL

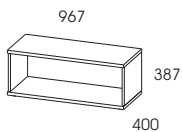

**A3-01**

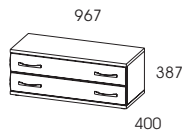

**A3-02a**  
**A3-02b**  
**A3-02c**  
**A3-02d**

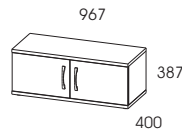

**A3-03a**  
**A3-03b**  
**A3-03c**

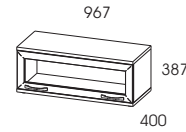

**A3-04a**

Omarica nizka 1D / MOŽNO OBESITI NA STENO  
Cabinet 1D height 02 / POSSIBLE TO HANG ON THE WALL

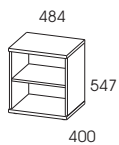

**A4-01**

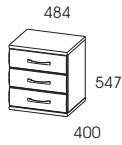

**A4-02a**  
**A4-02b**  
**A4-02c**  
**A4-02d**

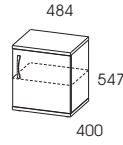

**A4-03a**  
**A4-03b**  
**A4-03c**

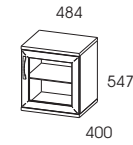

**A4-04a**

Omarica nizka 2D / MOŽNO OBESITI NA STENO  
Cabinet 2D height 02 / POSSIBLE TO HANG ON THE WALL

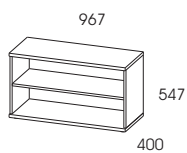

**A5-01**

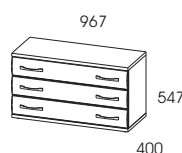

**A5-02a**  
**A5-02b**  
**A5-02c**  
**A5-02d**

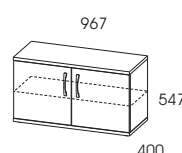

**A5-03a**  
**A5-03b**  
**A5-03c**

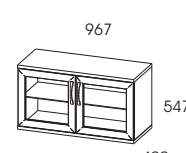

**A5-04a**

Omarica srednja 1D  
Cabinet 1D height -03

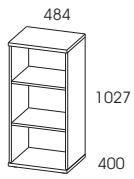

**A6-01**

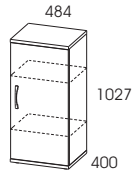

**A6-02a  
A6-02b  
A6-02c**

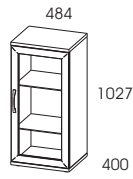

**A6-03a**



**A6-04a  
A6-04b  
A6-04c  
A6-04d**

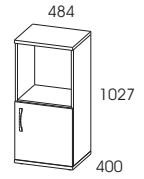

**A6-05a  
A6-05b  
A6-05c**



**A6-06a  
A6-06b  
A6-06c  
A6-06d  
A6-06e  
A6-06f**



**A6-07a  
A6-07b  
A6-07c  
A6-07d**



**A6-08a  
A6-08b  
A6-08c  
A6-08d**

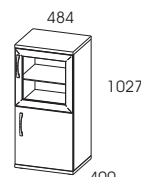

**A6-09a  
A6-09b  
A6-09c**

Omarica srednja 2D  
Cabinet 1D height 03

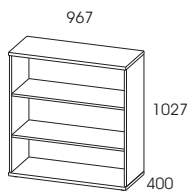

**A7-01**

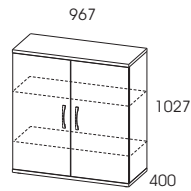

**A7-02a  
A7-02b  
A7-02c**

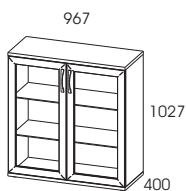

**A7-03a**

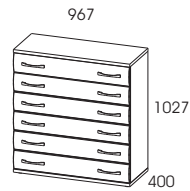

**A7-04a  
A7-04b  
A7-04c  
A7-04d**

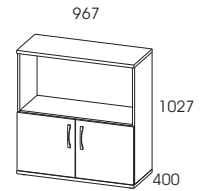

**A7-05a  
A7-05b  
A7-05c**

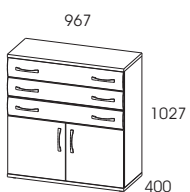

**A7-06a  
A7-06b  
A7-06c  
A7-06d  
A7-06e  
A7-06f**

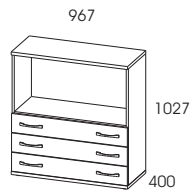

**A7-07a  
A7-07b  
A7-07c  
A7-07d**

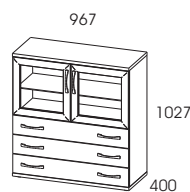

**A7-08a  
A7-08b  
A7-08c  
A7-08d**

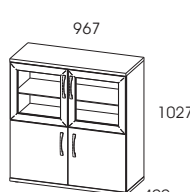

**A7-09a  
A7-09b  
A7-09c**

Omarica višja 1D  
Cabinet 1D height 04

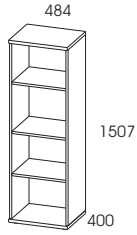

**A8-01**

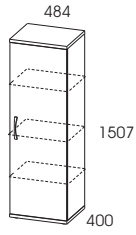

**A8-02a**  
**A8-02b**  
**A8-02c**

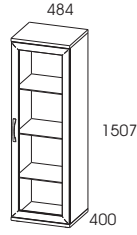

**A8-03a**

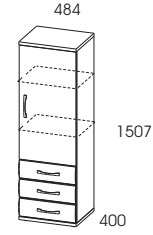

**A8-04a**  
**A8-04b**  
**A8-04c**  
**A8-04d**  
**A8-04e**  
**A8-04f**

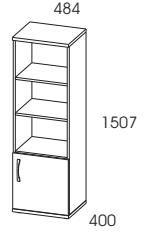

**A8-05a**  
**A8-05b**  
**A8-05c**



**A8-06a**  
**A8-06b**  
**A8-06c**  
**A8-06d**



**A8-07a**  
**A8-07b**  
**A8-07c**  
**A8-07d**  
**A8-07e**  
**A8-07f**

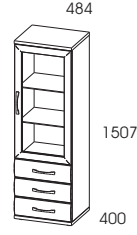

**A8-08a**  
**A8-08b**  
**A8-08c**  
**A8-08d**

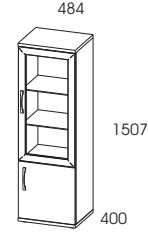

**A8-09a**  
**A8-09b**  
**A8-09c**

Omarica višja 2D  
Cabinet 2D height 04

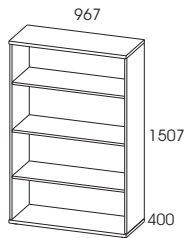

**A9-01**

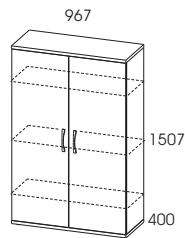

**A9-02a**  
**A9-02b**  
**A9-02c**

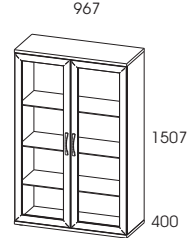

**A9-03a**

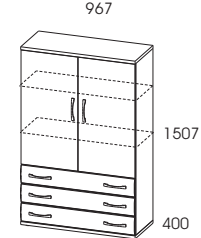

**A9-04a**  
**A9-04b**  
**A9-04c**  
**A9-04d**  
**A9-04e**  
**A9-04f**

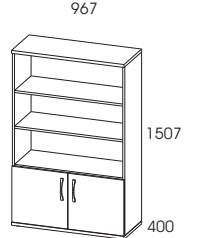

**A9-05a**  
**A9-05b**  
**A9-05c**



**A9-06a**  
**A9-06b**  
**A9-06c**  
**A9-06d**



**A9-07a**  
**A9-07b**  
**A9-07c**  
**A9-07d**  
**A9-07e**  
**A9-07f**



**A9-08a**  
**A9-08b**  
**A9-08c**  
**A9-08d**

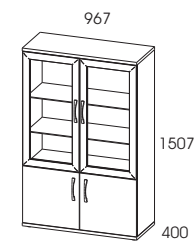

**A9-09a**  
**A9-09b**  
**A9-09c**

**Omarica visoka 1D**  
Cabinet 1D height 05

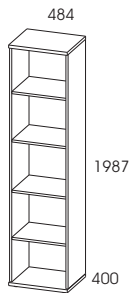

**A10-01**

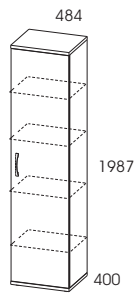

**A10-02a**  
**A10-02b**  
**A10-02c**

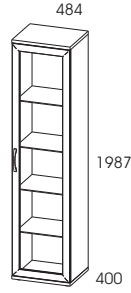

**A10-03a**

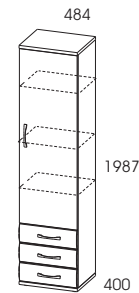

**A10-04a**  
**A10-04b**  
**A10-04c**  
**A10-04d**  
**A10-04e**  
**A10-04f**

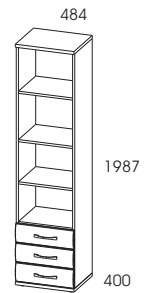

**A10-05a**  
**A10-05b**  
**A10-05c**  
**A10-05d**

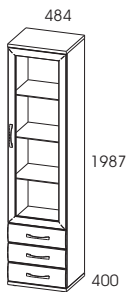

**A10-06a**  
**A10-06b**  
**A10-06c**  
**A10-06d**



**A10-07a**  
**A10-07b**  
**A10-07c**  
**A10-07d**  
**A10-07e**  
**A10-07f**

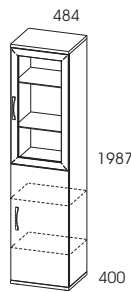

**A10-08a**  
**A10-08b**  
**A10-08c**

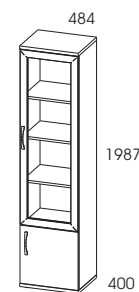

**A10-09a**  
**A10-09b**  
**A10-09c**

**Garderobna omara 1D**  
Wardrobe 1D

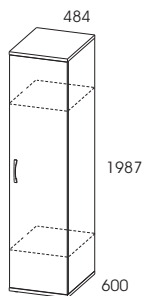

**A12-01a**  
**A12-01b**  
**A12-01c**

**Garderobna omara 2D**  
Wardrobe 2D

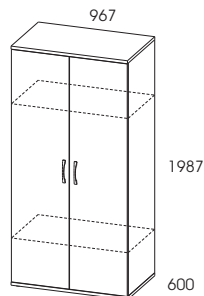

**A13-01a**  
**A13-01b**  
**A13-01c**

**Omarica kotna**  
Corner cabinet

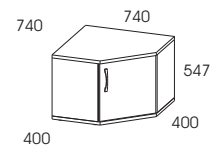

**A14-01**

Omarica visoka 2D  
Cabinet 2D height 05

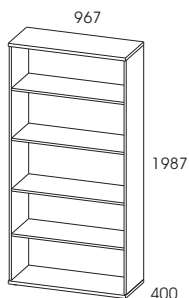

**A11-01**

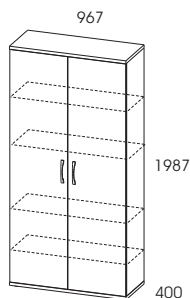

**A11-02a  
A11-02b  
A11-02c**

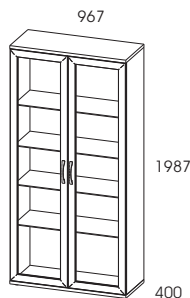

**A11-03a**

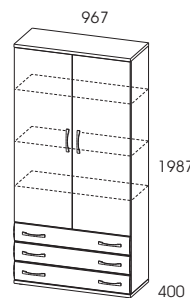

**A11-04a  
A11-04b  
A11-04c  
A11-04d  
A11-04e  
A11-04f**

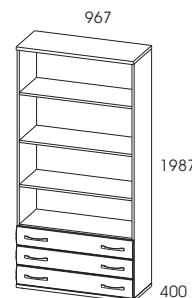

**A11-05a  
A11-05b  
A11-05c  
A11-05d**



**A11-06a  
A11-06b  
A11-06c  
A11-06d**

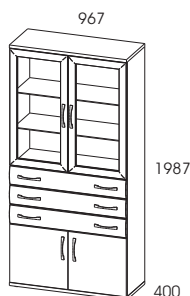

**A11-07a  
A11-07b  
A11-07c  
A11-07d  
A11-07e  
A11-07f**

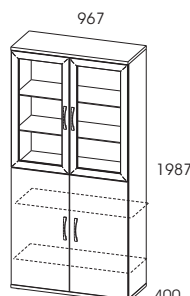

**A11-08a  
A11-08b  
A11-08c**

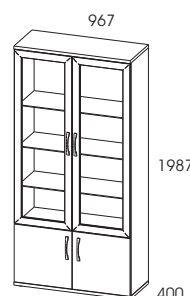

**A11-09a  
A11-09b  
A11-09c**

Omarica globoka 3D  
Deep 3D cabinet

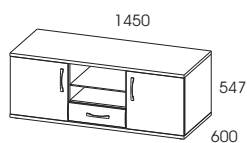

**A15-01a  
A15-01b  
A15-01c  
A15-01d  
A15-01e  
A15-01f**

Omarica 3D krivljena L  
Curved cabinet 3D L

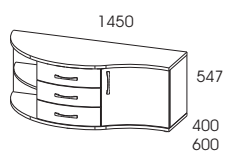

**A16-01**

Omarica 3D krivljena D  
Curved cabinet 3D R

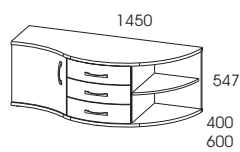

**A17-01**

Stojalo za plazma in LCD tv  
Stand for plazma and LCD tv

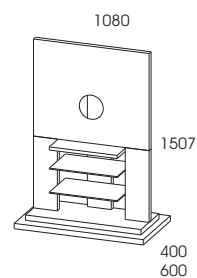

**A18-01**

Stena 3D visoka  
High wall 3D

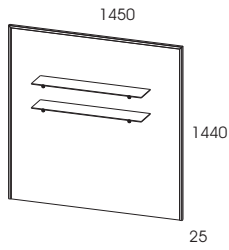

**A19-01**

Stena 2D visoka  
High wall 2D

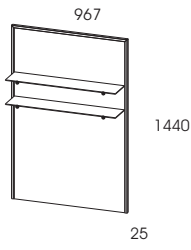

**A19-02**

Stena 3D nizka  
Short wall 3D

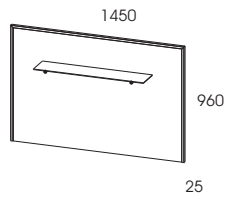

**A19-03**

Stenska polica  
Wall shelf

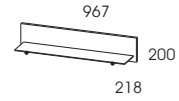

**A19-04**

Stena 3D visoka

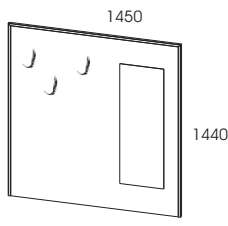

**A19-05**

Stena 2D visoka

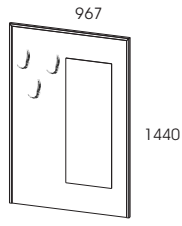

**A19-06**

Stojalo za DVD  
Stand for DVD player

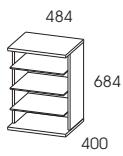

**A20-01**

Polica za CD/DVD  
CD/DVD shelf

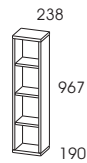

**A21-01**

Klubska miza  
Coffee table

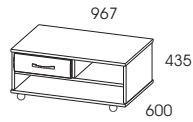

**A22-01a  
A22-01b  
A22-01c  
A22-01d**

Tv miza  
TV table

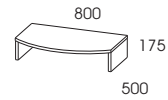

**A23-01**

Postelja s predalom  
Bed with drawer

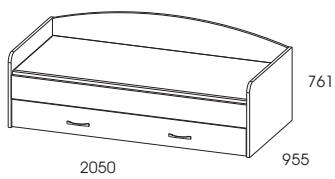

**A24-01**

Postelja  
Bed

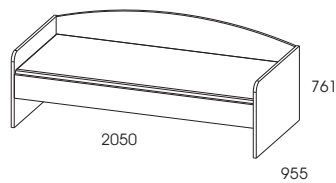

**A24-02**

Blazina  
Cushion

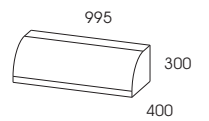

**A24-03**



Pisalna miza kratka  
Writing desk short

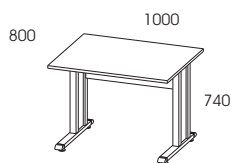

**A25-01**

Pisalna miza dolga  
Writing desk long

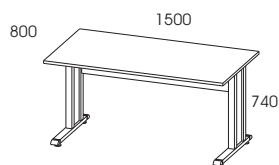

**A25-02**

Zaključek pisalne mize  
End attachment for writing

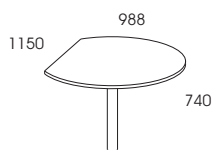

**A25-03**

Vstavek pisalne mize  
Writing desk insertion 90



**A25-04**

Vstavek pisalne mize 45  
Writing desk insertion 45

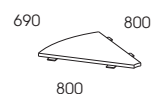

**A25-05**

Pisalna miza- leva ali desna  
Writing desk - left or right

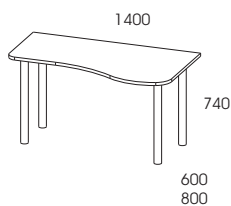

**A25-06**

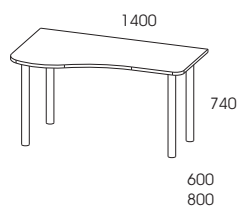

Mobilni predalčnik  
Mobile drawer



**A25-07a**  
**A25-07b**  
**A25-07c**  
**A25-07d**

Nosilec tipkovnice  
Keyboard tray

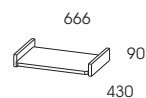

**A25-08**

Stojalo za monitor  
Working tray

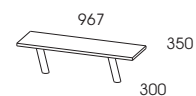

**A25-09**

Steklena polica 1D  
Glass shelf 1D



**A26-01**

Steklena polica 2D  
Glass shelf 2D

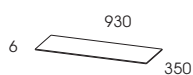

**A26-02**

Lesena polica 1D  
Wooden shelf 1D

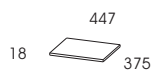

**A26-03**

Lesena polica 2D  
Wooden shelf 2D

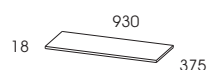

**A26-04**

Lučka za vitrino  
Light for glass cabinet



**A27-01**

Transformator za 6 lučk  
Converter for 6 light



**A27-02**

Ogledalo  
Mirror

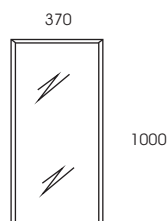

**A28-01**

# Sestavi / Compositions

**Sestav #01 / Composition #01**

- A3-04 1x
- A6-05 1x
- A10-02 1x
- A15-01 1x
- A19-04 1x

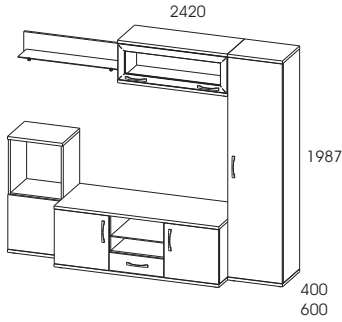

**Sestav #02 / Composition #02**

- A6-06 1x
- A10-03 1x
- A18-01 1x

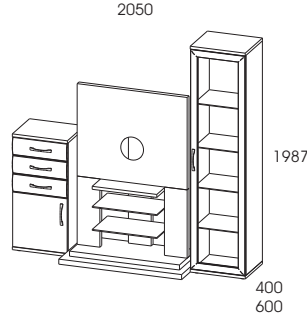

**Sestav #03 / Composition #03**

- A1-03 2x
- A1-04 1x
- A9-04 1x
- A5-04 1x
- A19-04 1x
- A20-01 1x

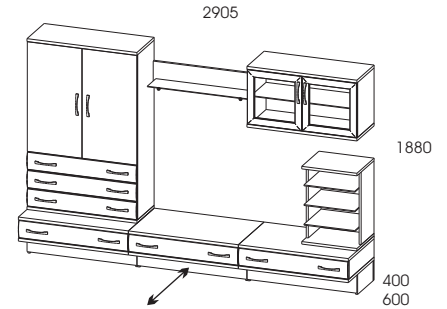

**Sestav #04 / Composition #04**

- A1-02 3x
- A3-04 1x
- A6-02 1x
- A10-03 1x
- A21-01 1x
- A23-01 1x

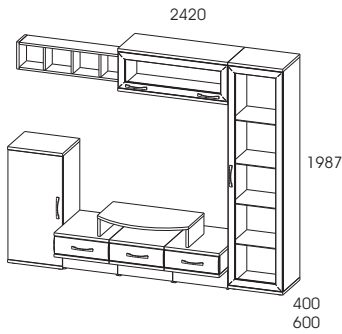

**Sestav #05 / Composition #05**

- A10-03 2x
- A10-05 1x
- A16-01 1x
- A19-01 1x

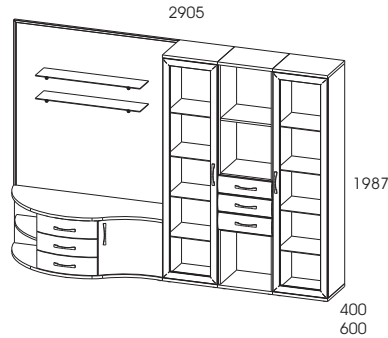

**Sestav #06 / Composition #06**

- A10-06 1x
- A13-01 1x
- A15-01 1x
- A19-01 1x
- A23-01 1x

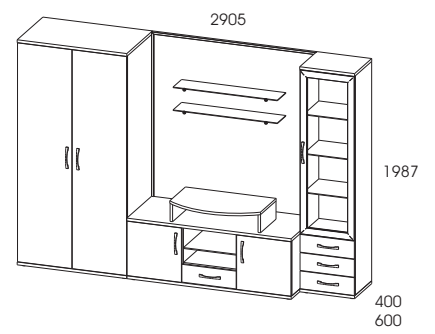

**Sestav #07 / Composition #07**

- A3-03 1x
- A3-02 1x
- A5-04 1x
- A18-01 1x
- A19-04 1x

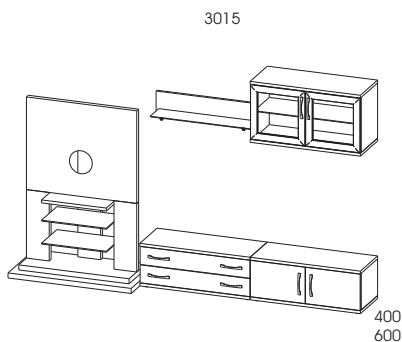

**Sestav #08 / Composition #08**

- A2-03 1x
- A3-04 1x
- A4-03 1x
- A5-02 1x
- A16-01 1x
- A19-04 3x

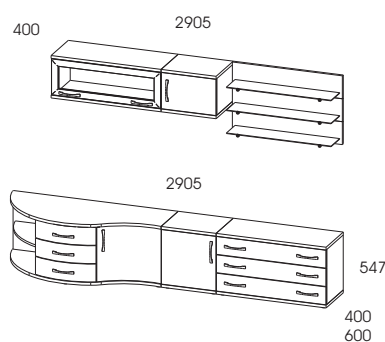

**Sestav #09 / Composition #09**

- A8-03 1x
- A8-06 1x
- A15-01 1x
- A19-03 1x

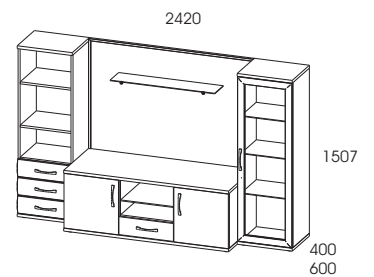

**Sestav #10 / Composition #10**

- A1-01 2x
- A1-02 1x
- A5-02 1x
- A5-03 1x
- A3-04 2x
- A19-04 1x

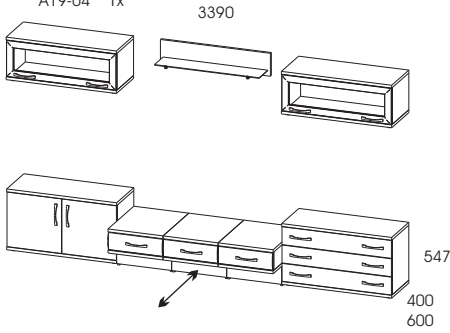

**Sestav #11 / Composition #11**

- A1-01 1x
- A1-03 2x
- A4-02 1x
- A4-03 1x
- A11-07 1x
- A19-04 2x

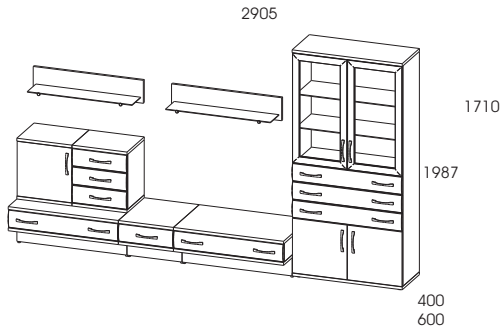

**Sestav #12 / Composition #12**

- A5-03 2x
- A12-01 1x
- A21-01 2x
- A24-02 1x
- A24-03 2x

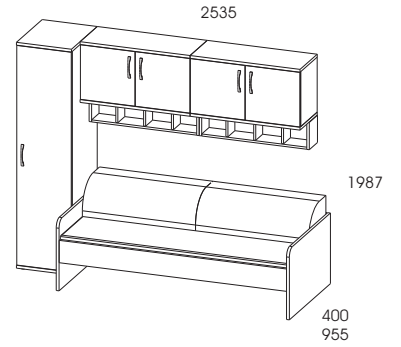

**Sestav #13 / Composition #13**

- A5-02 1x
- A6-07 1x
- A8-02 1x
- A10-03 1x
- A14-01 1x
- A15-01 1x
- A20-01 1x
- A21-01 1x

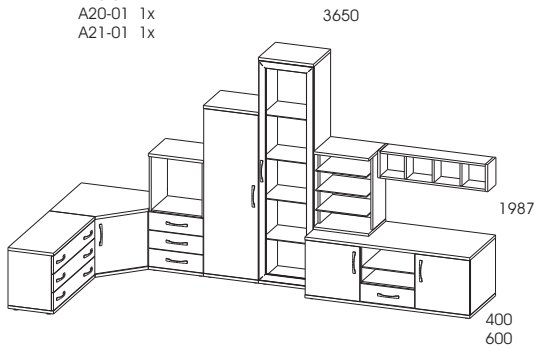

**Sestav #14 / Composition #14**

- A9-06 1x
- A21-01 1x
- A25-06 1x
- A25-07 1x
- A25-09 1x

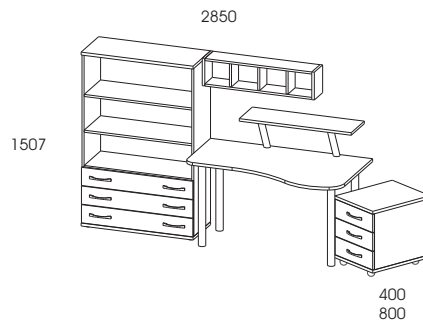

**Sestav #15 / Composition #15**

- A4-03 1x
- A6-07 1x
- A10-02 1x
- A10-09 1x
- A21-01 2x
- A25-02 1x

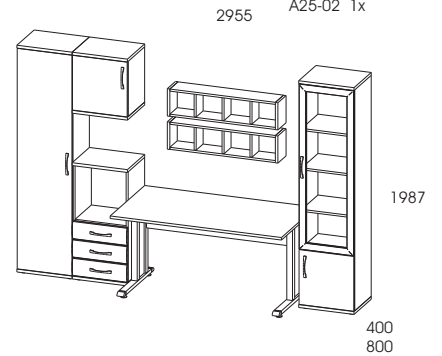

**Sestav #16 / Composition #16**

- A2-02 1x
- A4-02 1x
- A3-03 1x
- A21-01 2x
- A25-01 1x
- A25-02 1x
- A25-04 1x
- A25-07 1x

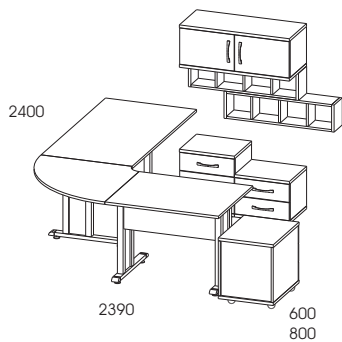

**Sestav #17 / Composition #17**

- A10-02 1x
- A16-01 1x
- A19-05 1x

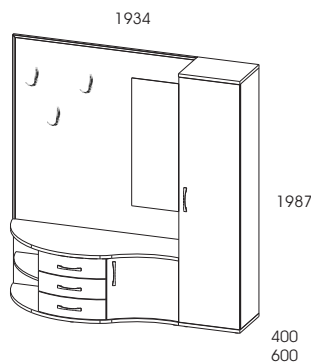

**Sestav #18 / Composition #18**

- A5-03 1x
- A10-04 1x
- A19-06 1x

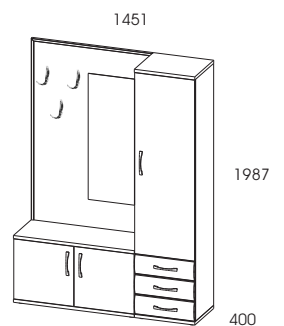



### Pohištvo Brežice d.d.

Aškerčeva ulica 7  
SI-8250 Brežice  
Slovenija

e-mail: [pohistvo.brezice@novoles.si](mailto:pohistvo.brezice@novoles.si)  
[www.novoles.si](http://www.novoles.si)

### Veleprodaja / Wholesale

Tel. +386 (0)7 49 92 812  
Fax: +386 (0)7 49 92 822

### Maloprodaja / Retail

#### Salon Straža

Na žago 6  
SI-8351 Straža  
Slovenija  
Tel. +386 (0)7 38 48 358  
Fax: +386 (0)7 38 48 233

#### Salon Brežice

Aškerčeva ulica 7  
SI-8250 Brežice  
Slovenija  
Tel. +386 (0)7 49 92 813  
Fax: +386 (0)7 49 92 837

Vsi podatki in slike v katalogu so simbolični. Proizvajalec si pridržuje pravico do sprememb.  
All data and pictures in the catalogue are symbolic. The manufacturer reserves the right to make changes.

